



## Description

NETWORK's LED Flood light is ideal for landscapes, display signage, building facades, pathways and parking area. Replace existing HID flood light. Standard Photocell (dusk-to-dawn function) is included as default. Die-cast magnesium housing provide good heat dissipation, long life, low maintenance, and high efficiency. Please note that this product is not suitable for use in seaside areas or environments with high salt spray concentration.

## Application

- Landscapes
- Display signage
- Building facades
- Pathways
- Parking area

## Certificate

- UL(Pending)
- DLC(Pending)

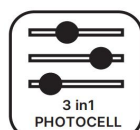
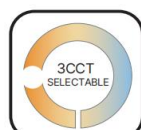

## Key Features

- High efficacy up to 150lm/W.
- 3CCT(3000/4000/5000K) and Wattages Selectable offer SKU reduction.
- Die-cast magnesium housing provides good heat dissipation and a durable lifetime.
- 4 kinds of mounting brackets available (Knuckle Mount, Trunnion Mount, Yoke Mount, Slipfitter Mount).
- Standard Photocell (dusk-to-dawn function) is included as default.
- AC120-277V .

Durable die-cast magnesium housing



3 Kinds of mounting brackets options

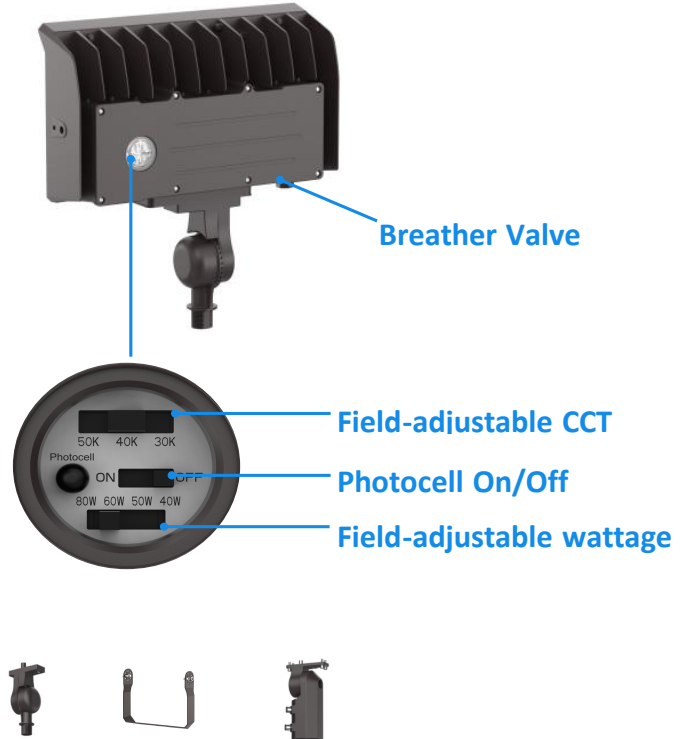

## Performance Summary

Model NO. #	Size	Watts	3 CCT	LPW	Lumens(±10%)	Voltage	DIM	CRI	Beam Angle
SU-FL-40W-CCT-G1	7"	40/35/30/25W Selectable	3CCT Selectable 3000K 4000K 5000K	150lm/W	6000LM@40W	AC120-277V	0-10V	80	7H6V
SU-FL-80W-CCT-G1	9"	80/60/50/40W Selectable			12000LM@80W				
SU-FL-150W-CCT-G1	12"	150/120/100/80W Selectable			22500LM@150W				

Remarks: 1. All above efficacy and lumens are subject to CRI>80 @4000K, please check IES files for accurate data.

2. SU-FL, xC: Use any character to represent the shell color. The default null value is brown, black is represented by BL, and white by WH,GX for commercial, can be any two characters or blank.

3. Factory setting: Photocell is ON, Max wattage, 5000K.

## Performance

- LED Type: SMD2835
- Frequency: 50/60HZ
- THD: <20%
- Power Factor: ≥0.90
- IP Rating: IP65
- Operating Temp.: -40°F to 113°F (-40°C to +45°C)
- Surge Protection: L/N 6KV, L/N-P 6KV(for 80/100/120/150/180W)  
L/N 4KV, L/N-P 6KV(for 20/40/60W)

## Construction







- Lens: Polycarbonate
- Housing: Die-cast Magnesium
- Finish: Bronze (Standard), Custom finishes available

## Mounting

- Knuckle Mount
- Trunnion Mount
- Yoke Mount
- Slipfitter Mount



## Accessories (Sold separately)

Picture	Item #	Description
	SU-FL-40WUB-G1	Mounting Bracket, Yoke Mount for 20W, 40W, Bronze finish
	SU-FL-40W80WKN-G1	Mounting Bracket, Knuckle Mount for 20W-180W, Bronze finish
	SU-FL-80WUB-G1	Mounting Bracket, Yoke Mount for 60W, 80W, Bronze finish
	SU-FL-150WSF-G1	Mounting Bracket, Slipfitter Mount for 100W, 120W, 150W, 180W, Bronze finish
	SU-FL-150WUB-G1	Mounting Bracket, Yoke Mount for 150W, 180W, Bronze finish
	ACC-FL08-MP-BZ-20W	Mounting Plate for 20W-180W, Bronze finish

## Mounting Plate Installation



## Product Dimension

(unit: mm & inch)

Fixture only

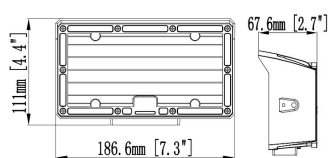

40W

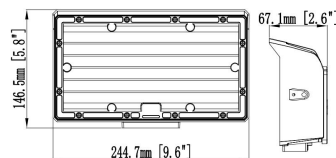

80W

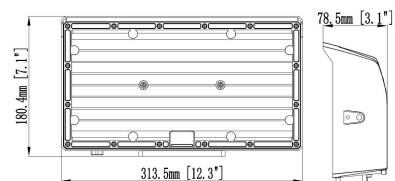

150W

## With Knuckle Bracket

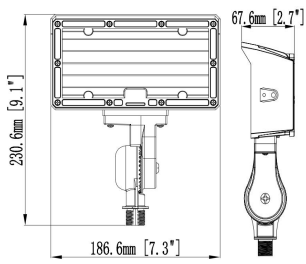

**40W**

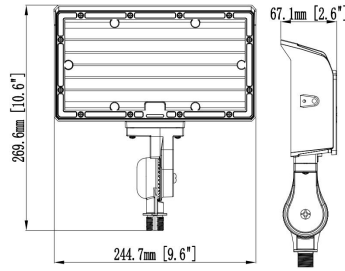

**80W**

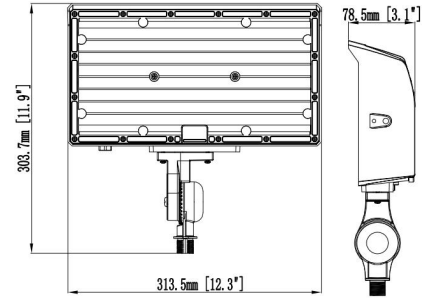

**150W**

## With Yoke Bracket

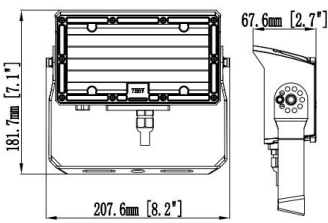

**40W**

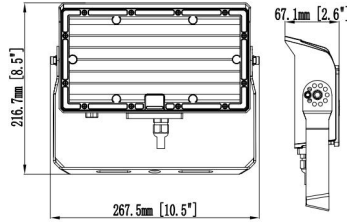

**80W**

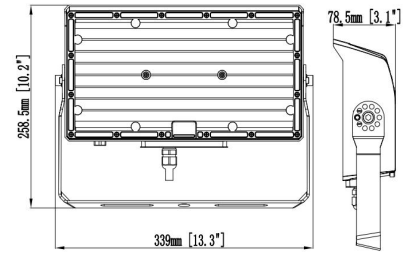

**150W**

## With Slipfitter Bracket

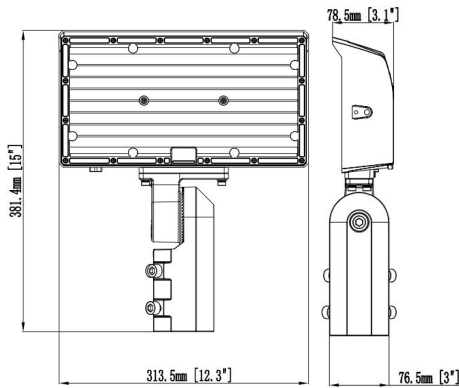

**150W**

## Package Info.(Fixture only)

Product Size (inch & mm)	Product & Package Weight(KG)				Q'ty/BOX (PCS)	Q'ty/CTN (PCS)	Carton Size (inch & mm)	20GP (PCS)	40HQ (PCS)
	N.W./PC	G.W./PC	N.W./CTN	G.W./CTN					
<b>40W</b> 7.3"×4.4"×2.7" 186.6×111×67.6mm	0.85	0.92	8.45	9.78	1	10	15.8"×15"×7.1" 401×382×180mm	10080	22620
<b>80W</b> 9.6"×5.8"×2.6" 244.7×146.5×67.1mm	1.32	1.42	7.89	8.93	1	6	18.0"×10.4"×8.5" 456×265×216mm	6360	14520
<b>150W</b> 12.3"×7.1"×3.1" 313.5×180.4×78.5mm	1.93	2.08	7.72	8.81	1	4	13.9"×13.1"×9.8" 354×334×250mm	3672	8400

## Package Info.(Fixture with Knuckle Bracket)

Product Size (inch & mm)	Product & Package Weight(KG)				Q'ty/BOX (PCS)	Q'ty/CTN (PCS)	Carton Size (inch & mm)	20GP (PCS)	40HQ (PCS)
	N.W./PC	G.W./PC	N.W./CTN	G.W./CTN					
<b>40W</b> 7.3"×9.1"×2.7" 186.6×230.6×67.6mm	0.97	1.08	7.72	9.18	1	8	15.8"×12.1"×10.9" 401×308×278mm	6592	15336
<b>80W</b> 9.6"×10.6"×2.6" 244.7×269.6×67.1mm	1.44	1.59	8.61	10.05	1	6	18"×10.4"×12.4" 456×265×315mm	4452	10560
<b>150W</b> 12.3"×12"×3.1" 313.5×303.7×78.5mm	2.08	2.29	8.32	9.74	1	4	13.9"×13.1"×13.7" 354×334×349mm	2448	5880

## Package Info.(Fixture with Yoke Bracket)

Product Size (inch & mm)	Product & Package Weight(KG)				Q'ty/BOX (PCS)	Q'ty/CTN (PCS)	Carton Size (inch & mm)	20GP (PCS)	40HQ (PCS)
	N.W./PC	G.W./PC	N.W./CTN	G.W./CTN					
<b>40W</b> 8.2"×7.2"×2.7" 207.6×181.7×67.6mm	1.08	1.16	8.64	9.75	1	8	17.9"×12.1"×8.1" 454×308×207mm	7360	18336
<b>80W</b> 10.5"×8.5"×2.6" 267.5×216.7×67.1mm	1.60	1.70	9.60	10.73	1	6	18"×11.4"×9.5" 456×290×242mm	5238	12000
<b>150W</b> 13.3"×10.2"×3.1" 339×258.5×78.5mm	2.36	2.51	9.43	10.62	1	4	14.3"×13.9"×11.2" 363×354×284mm	3072	7128

## Package Info.(Fixture with Slipfitter Bracket)

Product Size (inch & mm)	Product & Package Weight(KG)				Q'ty/BOX (PCS)	Q'ty/CTN (PCS)	Carton Size (inch & mm)	20GP (PCS)	40HQ (PCS)
	N.W./PC	G.W./PC	N.W./CTN	G.W./CTN					
<b>150W</b> 12.3"×15"×3.1" 313.5×381.4×78.5mm	2.74	2.93	10.96	12.37	1	4	15.2"×13.1"×15.9" 386×334×404mm	1980	4920