

Catalog Number:

Project Name:

Note:

Date:

Type:

DESCRIPTION

A flexible downlight solution supports surface mounting and retrofit installation .

High quality Iron shell with frosted PC diffuser.

Features color tunable technology lets the user choose between 2700K, 3000K, 3500K, 4000K, or 5000K.

Wet-location rated, ideal for bathrooms, laundry, porches and garage work rooms.



4"



6"



8"



BASED ON SAMPLE SETTING. ACTUAL LUMENS MAY VARY

MODEL#	SIZE	WATTAGE	5CCT	LUMENS
SU-DL4IN-10WTR5CT-GX	4inch	10W	2700K	580lm
			3000K	600lm
			3500K	600lm
			4000K	630lm
			5000K	600lm

MODEL#	SIZE	WATTAGE	5CCT	LUMENS
SU-DL6IN-15WTR5CT-GX	6inch	15W	2700K	960lm
			3000K	960lm
			3500K	1000lm
			4000K	1050lm
			5000K	960lm

MODEL#	SIZE	WATTAGE	5CCT	LUMENS
SU-DL8IN-18WTR5CT-GX	8inch	18W	2700K	1070lm
			3000K	1100lm
			3500K	1170lm
			4000K	1200lm
			5000K	1080lm

FEATURES

- Low profile
- Continuous dimming from 100% to 5% with many Triac Dimmers
- Provide true color rendering with 90+ CRI

COLOR OPTIONS



White



Black



Brushed Nickel

TECHNICAL SPECIFICATION

VOLTAGE	120V
POWER FREQUENCY	60Hz
POWER FACTOR	>0.9
5CCT	2700K 3000K 3500K 4000K 5000K
CRI	90
BEAM ANGLE	110°
MATERIAL	Iron+PC
COLOR	White / Black / Brushed Nickel
LIFESPAN	≥ 50,000hours
OPERATING TEMP	(-4°F~ 113°F) -20~45 °C
DIMMABLE	Triac Dimming
RATING	Suitable for Wet Locations
WARRANTY	5 year limited

INSTALLATION

With multiple apertures, can be installed into any 5 or 6inch Recessed Can ,or 2.75/3.5inch and 4inch Junction Box, ideal for under soffit and shower installations.

DIMMING

Compatible with most triac dimmers to give user a smooth 100%-5% dimming to choose the desired brightness. Please check the recommended dimmer list in next page.

ELECTRICAL

This fixture is built with the highest quality 120V drivers, ensuring energy efficiency.

ENERGY SAVINGS

80% more energy savings than halogen lamps.

LISTING

ETL Listed. FCC.Title24.



Specification subject to change without notice

Catalog Number: _____ Project Name: _____ Note: _____ Date: _____ Type: _____

INSTALLATION HOLE POSITION

4inch

- 3.5" Junction Box installation hole



6inch

- 5" or 6" Recessed installation hole
- 2.75" Junction Box installation hole
- 3.5" Junction Box installation hole
- 4" Junction Box installation hole

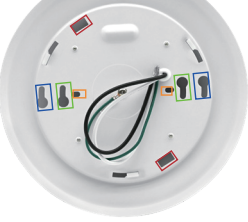

8inch

- 5" or 6" Recessed installation hole
- 2.75" Junction Box installation hole
- 3.5" Junction Box installation hole



CCT SELECTION

Anticlockwise to open the outside lens

Flip the switch to choose desired CCT

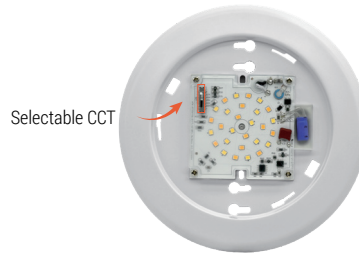

DIMENSION

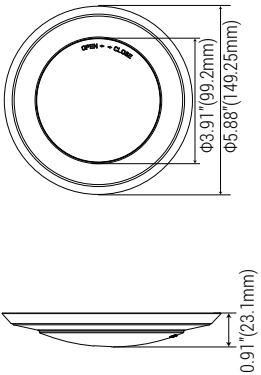
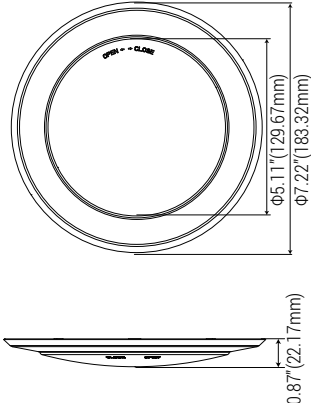
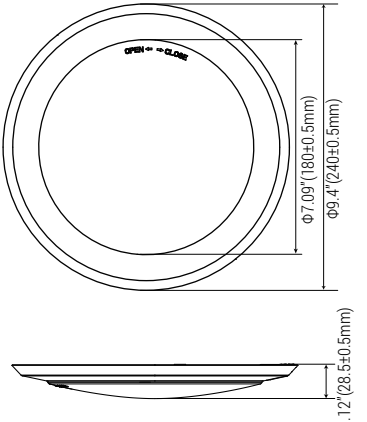
4inch	6inch	8inch
		



















RECOMMENDED DIMMER

LUTRON			LEVITON	
TG-600PR-WH	TGCL-153PH-LA	SCL-153PH-WH	6672	
S-600PR-WH	SLV-600P-AL	DVCL-153P	6674	PL06
CTCL-153PDH-WH	DV-600PR-WH	PD-6WCL	DSL06	RNL06
		MSCL-OP153M		
		MACL-153M//MA-R		

Specification subject to change without notice

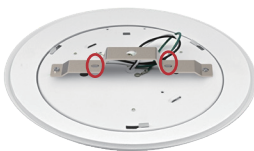
Catalog Number: Project Name: Note: Date: Type:

ACCESSORIES

	Surface Mount Accessories			Retrofit Accessories		
4inch	<p>3.5" Junction Box installation hole</p> 	<p>Wire Nuts</p> 	<p>Screws 1</p> 	/		
6inch	<p>2.75"/3.5"/4" Junction Box installation hole</p> 	<p>Wire Nuts</p> 	<p>Screws 1</p> 	<p>5/6" Recessed installation hole</p> 	<p>Mounting Springs</p> 	<p>Wire Nuts</p> 
8inch	<p>3.5" Junction Box installation hole</p> 	<p>Wire Nuts</p> 	<p>Screws 1</p> 	<p>5/6" Recessed installation hole</p> 	<p>Mounting Springs</p> 	<p>Screws 3</p> 
	<p>2.75" Junction Box installation hole</p> 	<p>Mounting Bracket</p> 	<p>Screws 2</p> 			
		<p>Wire Nuts</p> 	<p>Screws 1</p> 