

Honeycomb lamp

APPLICATION

Car wash, car beauty, auto repair, garage, film, workstation

Product Features

- ◎The material of the lamp body adopts a semi aluminum and semi plastic process, which results in higher structural strength, better heat dissipation performance, and longer service life;
- ◎Single lamp tube power 8W, higher brightness;
- ◎The product has no flicker and does not harm the eyes;
- ◎The product can achieve different shapes through different connectors, making it convenient for users to DIY;
- ◎Easy installation, quick insertion;



PRODUCT DATASHEET

5 Holes Honeycomb lamp series

AL+PC | IP20 | ETL | AC100-277V |

Model No.	Input voltage	Power	LED	Color	Beam Angle	LM/W
SU-HC5-192W65K-G1	100-277V	24*8=192W	SMD2835/3V	6500K	120°	110~120lm/w

Assembly diagram

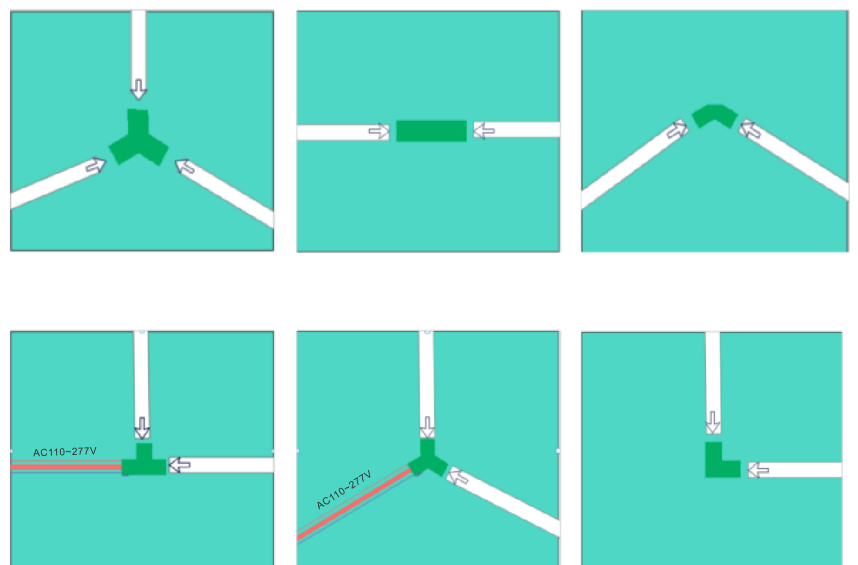
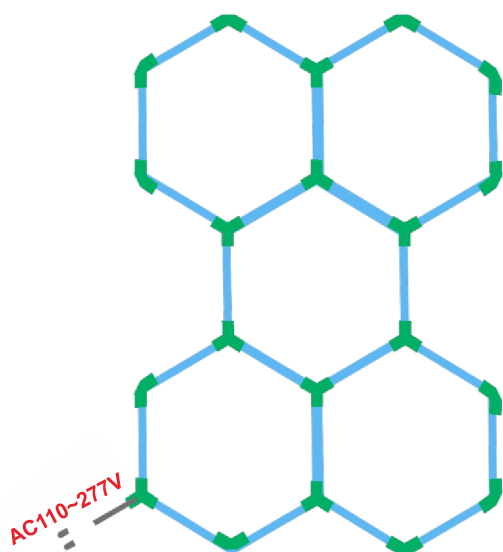
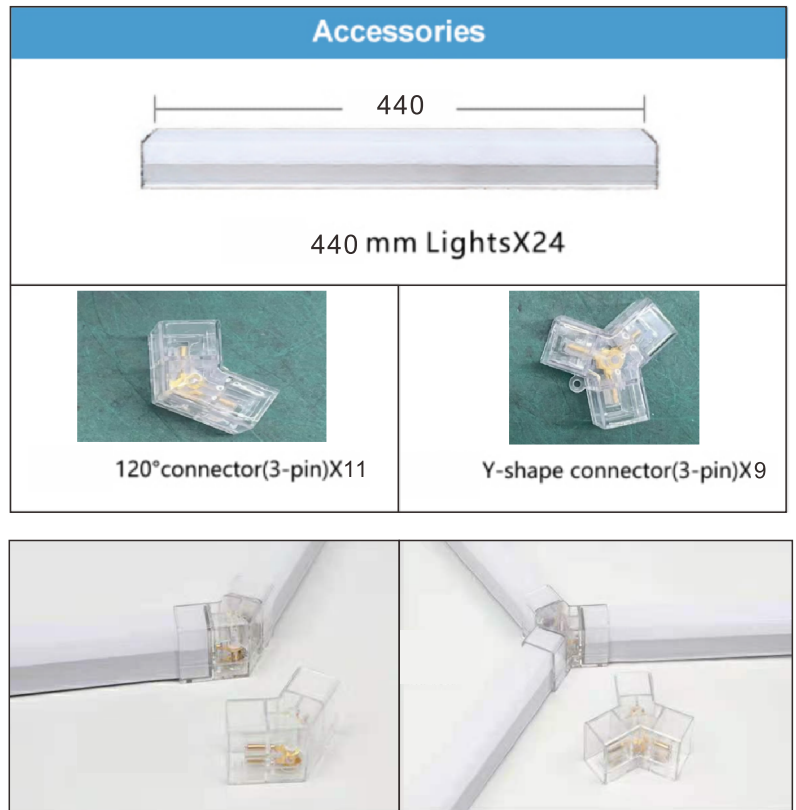
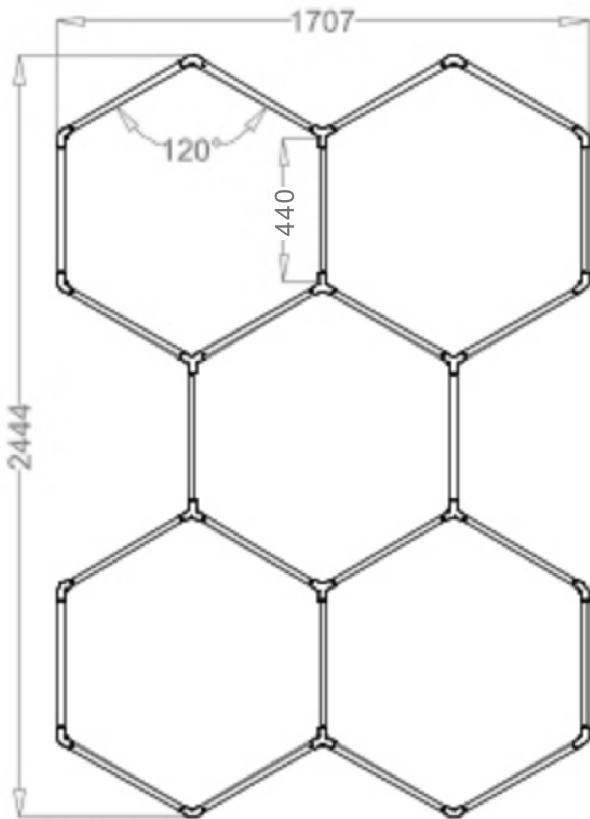







WARNING

1. Switch off before installation.
2. Switch on only after complete installation and examination of the circuit.
3. Professional electrician for installation and maintenance only.

PACKING LIST

5 Holes Honeycomb lamp series

	Packing list			Parameter			
Light source long tube size 	0PCS	ribbon	1PCS	Product model	SU-HC5-192W65K-G1	input voltage	100-277V
Light source tube size	24PCS	Power input line	1PCS	Overall lamp size	2350*1650mm	colour temperature	6500K
Straight connector 	0PCS	degree connector 	1PCS	Luminous surface width dimension	20-22MM	Total lamp power	192W
Tee joint 	9PCS	degree right angle joint 	0PCS	rough weight	3.2KG	colour rendering index	80
	0PCS	instructions	1PCS	Package size	46*19*19mm	Photoeffect	110-120 LM/W

Installation considerations:

Please check the quantity and completeness of the lamp tubes, fittings and accessories according to the packing list. Install the main body of the jointing lamp according to the diagram, and check whether the joint is plugged in place. Use the mounting rack to lift the rack before fixing the lamp.

Must use the standard municipal electricity AC 110V-AC277V voltage supply.

It is forbidden to install lamps and lanterns with live electricity, which may damage lamps and lanterns or injure people with electricity leakage.

Package

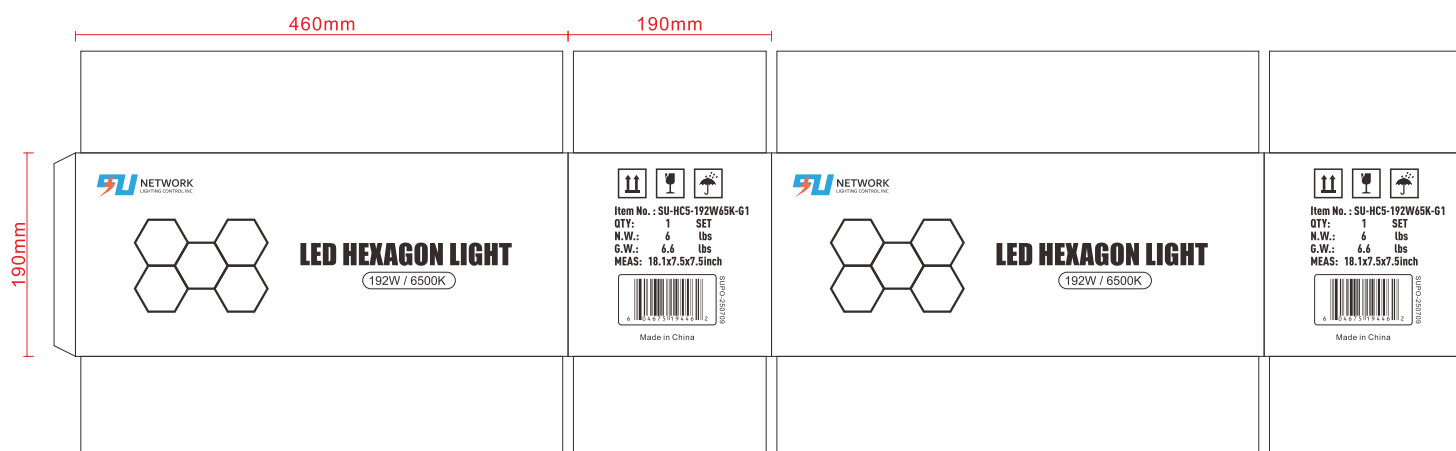

Item No.	Meas	QTY	N.W.	G.W.
SU-HC5-192W65K-G1	18.1x7.5x7.5inch	1 SET	6 lbs	6.6 lbs

INSTALLATION INSTRUCTIONS

1. Install with zip ties to grid and square hanger type workstations.

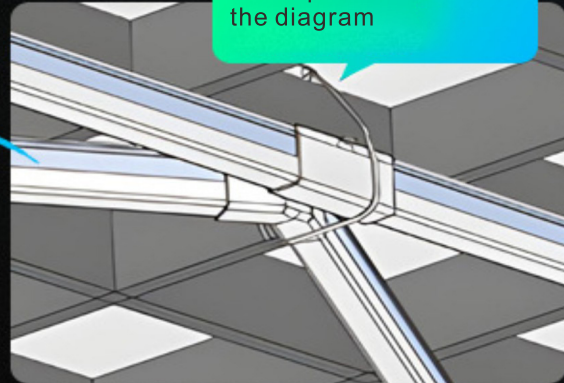
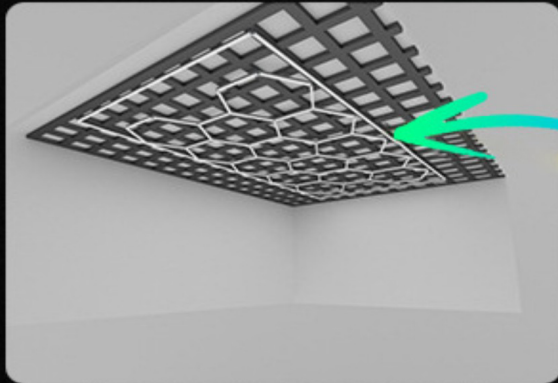

2. Install iron buckles onto the ceiling to fix the screw station.

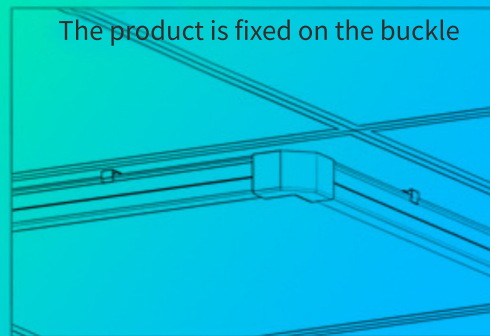
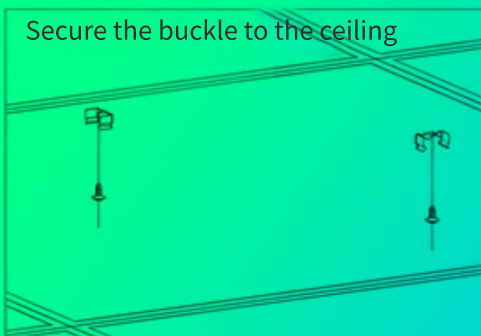

3. Fix the buckle on the ceiling with self tapping screws.



Step 1: Fix the buckle with screws.



Step 2: Press the lamp tube into the buckle to fix it.

