

# Honeycomb lamp

## APPLICATION

Car wash, car beauty, auto repair, garage, film, workstation

### Product Features

- ◎The material of the lamp body adopts a semi aluminum and semi plastic process, which results in higher structural strength, better heat dissipation performance, and longer service life;
- ◎Single lamp tube power 8W, higher brightness;
- ◎The product has no flicker and does not harm the eyes;
- ◎The product can achieve different shapes through different connectors, making it convenient for users to DIY;
- ◎Easy installation, quick insertion;



# PRODUCT DATASHEET

## 14 Holes Honeycomb lamp series

AL+PC | IP20 | ETL | AC100-277V |

Model No.	Input voltage	Power	LED	Color	Beam Angle	LM/W
SU-HC14-680W65K-G1	100-277V	680W	SMD2835/3V	6500K	120°	110~120lm/w

### Assembly diagram

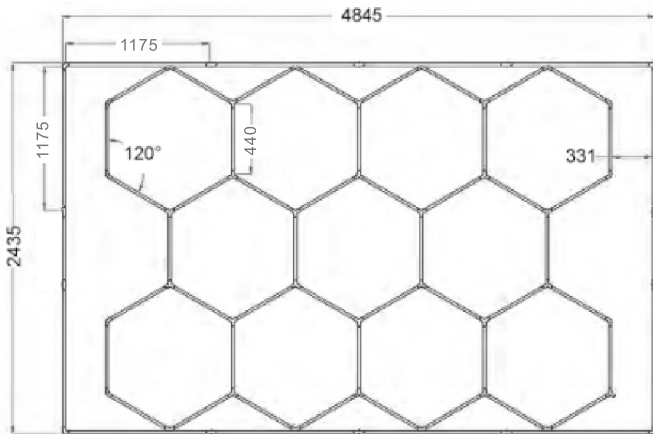

#### Accessories

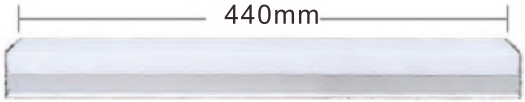

440mm

440mm Lights x 57



1175 mm

1175mm Lights x 12

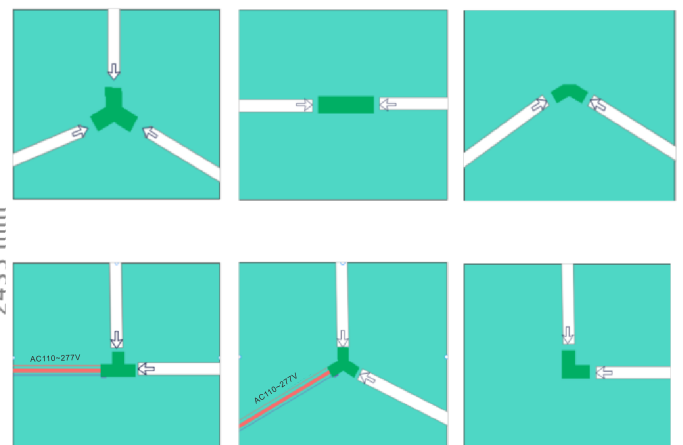
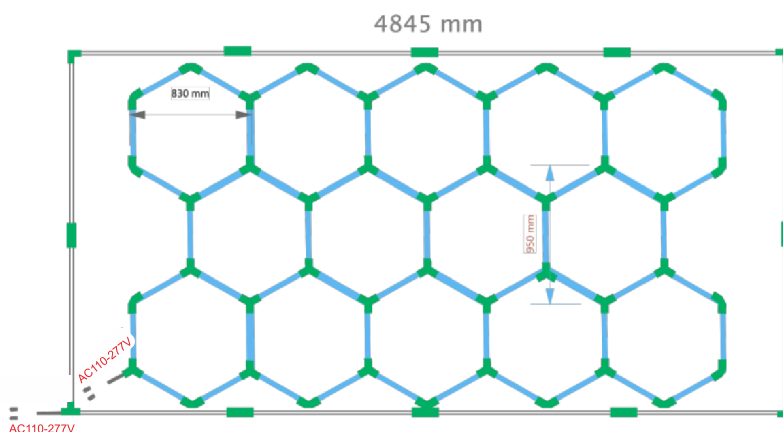
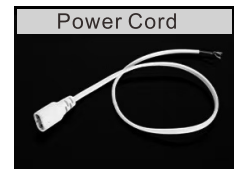
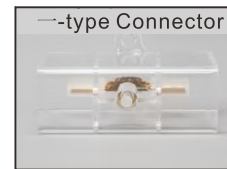
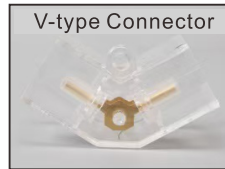
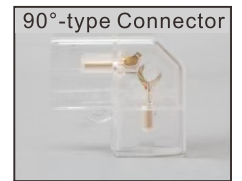
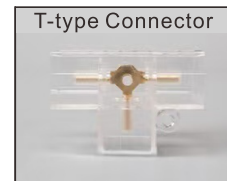
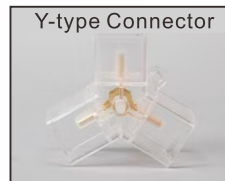





### WARNING

1. Switch off before installation.
2. Switch on only after complete installation and examination of the circuit.
3. Professional electrician for installation and maintenance only.

# PACKING INFORMATION

## 14 Holes Honeycomb lamp series

	Packing list			Parameter			
Light source long tube size	12PCS	ribbon	1PCS	Product model	SU-HC14-680W65K-G1	input voltage	100-277V
Light source tube size	57PCS	Power input line	2PCS	Overall lamp size	2435*4845mm	colour temperature	6500K
Straight connector 	8PCS	degree connector 	17PCS	Net Weight	23.9Lbs	Total lamp power	680W
Tee joint 	27PCS	degree right angle joint 	3PCS	Rough weight	26.5Lbs	colour rendering index	Ra>80
	1PCS	instructions	1PCS	Package size	1210*190*145mm	Photoeffect	110-120LM/W

### Installation considerations:

Please check the quantity and completeness of the lamp tubes, fittings and accessories according to the packing list.

Install the main body of the jointing lamp according to the diagram, and check whether the joint is plugged in place.

Use the mounting rack to lift the rack before fixing the lamp.

Must use the standard municipal electricity AC 110V-AC277V voltage supply.

It is forbidden to install lamps and lanterns with live electricity, which may damage lamps and lanterns or injure people with electricity leakage.

### Package

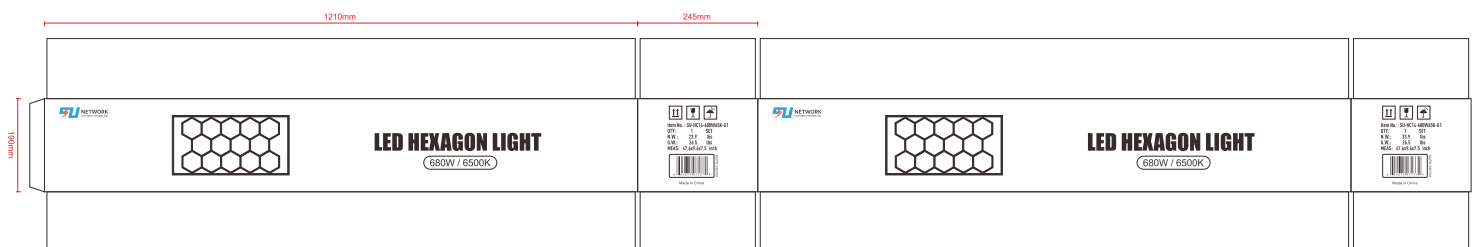

Item No.	Meas	QTY	N.W.	G.W.
SU-HC14-680W65K-G1	47.6x9.6x7.5 inch	1 SET	23.9 lbs	26.5 lbs

# INSTALLATION INSTRUCTIONS

**1.** Install with zip ties to grid and square hanger type workstations.

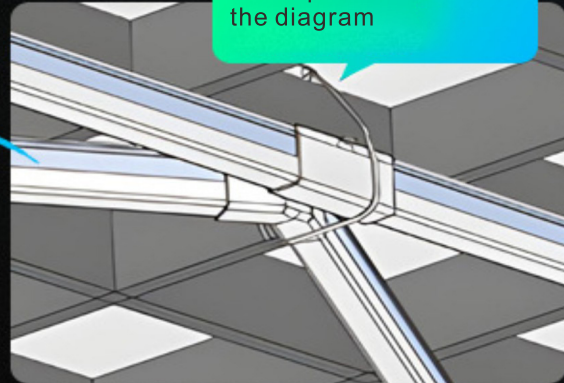
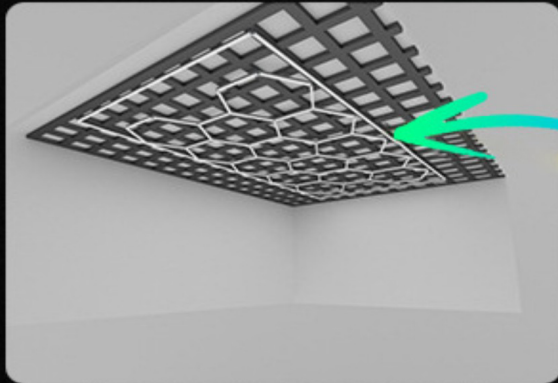

**2.** Install iron buckles onto the ceiling to fix the screw station.

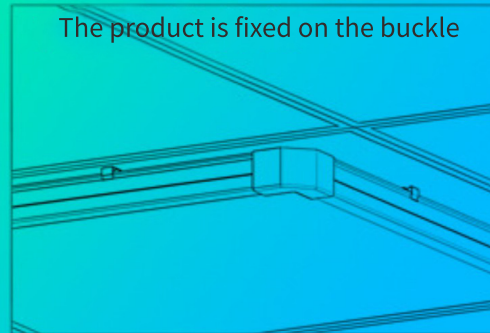
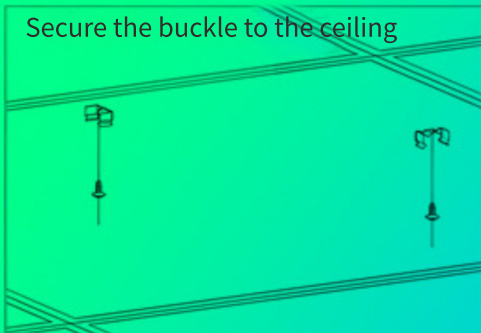

**3.** Fix the buckle on the ceiling with self tapping screws.



**Step 1:** Fix the buckle with screws.



**Step 2:** Press the lamp tube into the buckle to fix it.

